

Sanitana

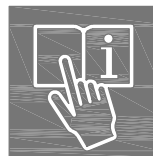

# UNIC

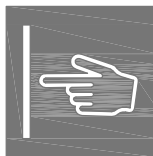
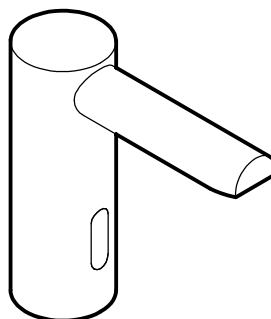
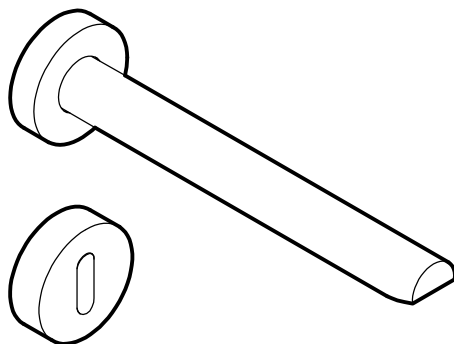

**TUNICBPS101M0**

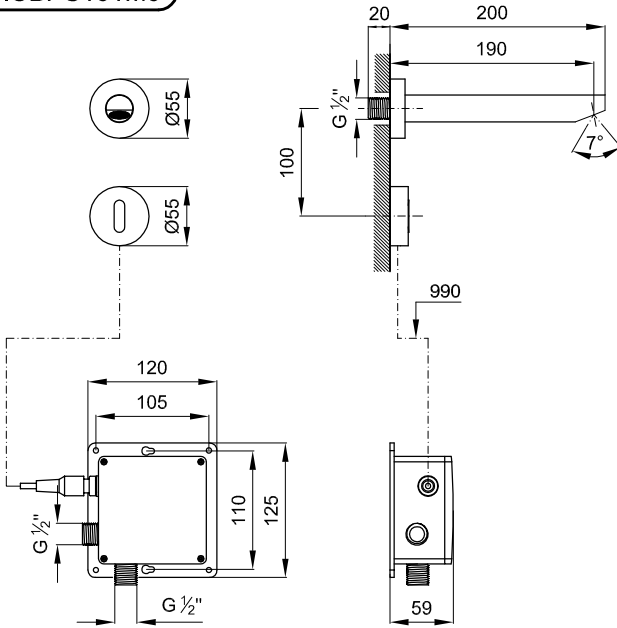

**Q**  
(3 bar)



**l/min**

**14**

**TUNICBPS201M0**

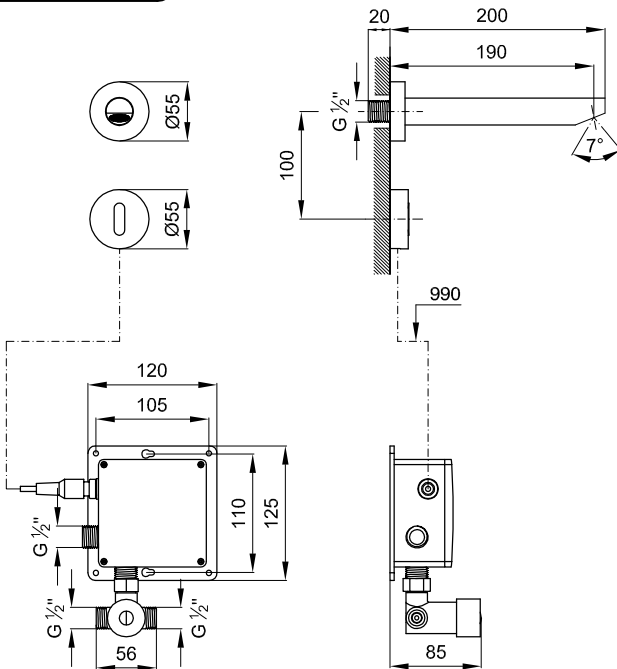

**Q**  
(3 bar)



**l/min**

**14**

**TUNICLS101M0**

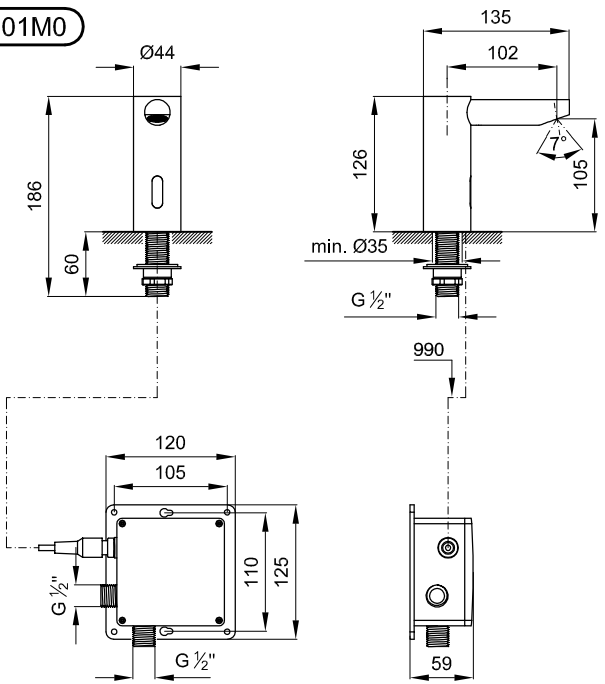

**Q**  
(3 bar)



**l/min**

**18**

**TUNICLS201M0**

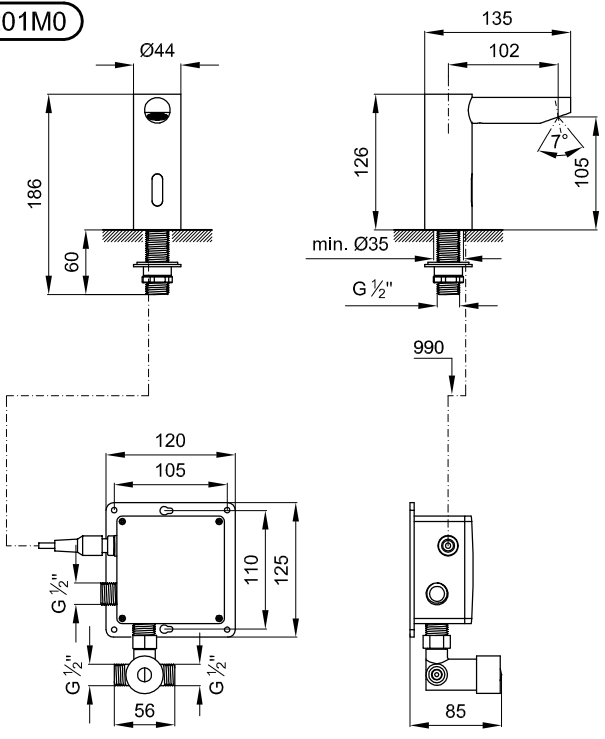

**Q**  
(3 bar)



**l/min**

**18**

1

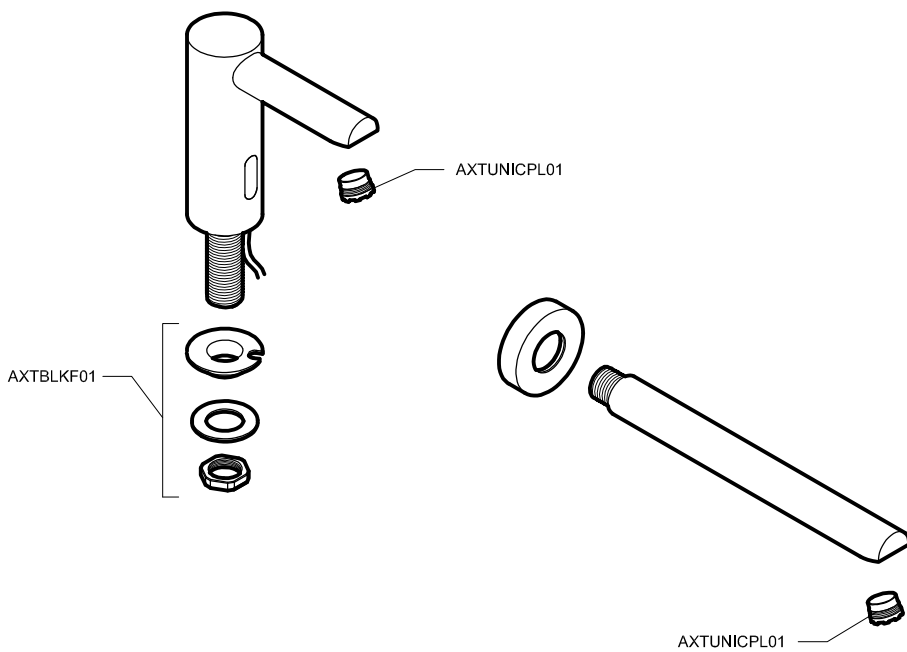
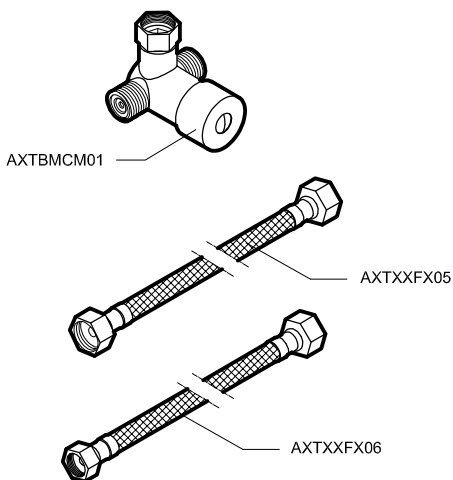
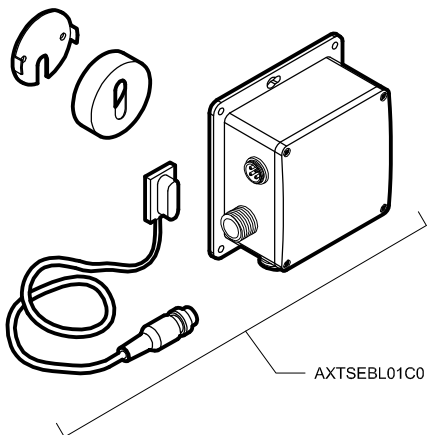

2

Pré-Instalação - Preinstalación - Pre-Instalation - Pré-Installation



Ø6

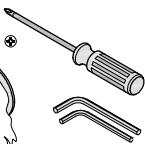
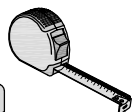
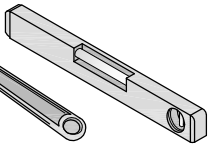
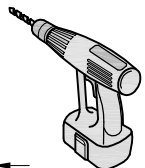

**P**  
P bar

MAX. 10

1

5

1

**T**  
°C

- 90 MAX.

- 65  
- 45

1 Água - 1 Agua - 1 Water - 1 Eau

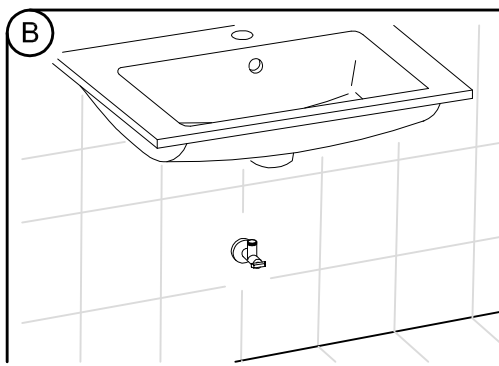
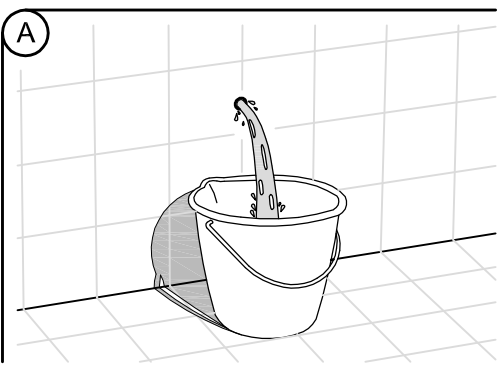

2 Águas - 2 Aguas - 2 Waters - 2 Eaux

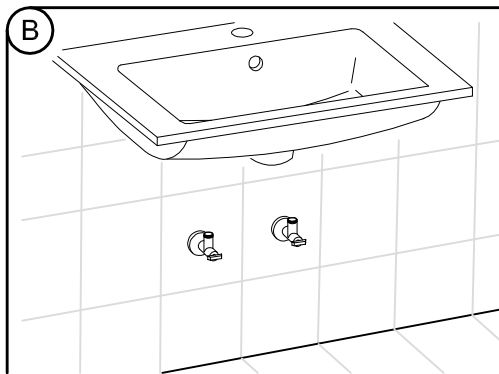
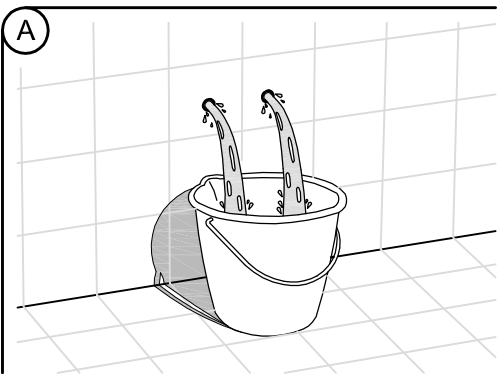

3



Instalação - Instalación - Instalation - Installation

A

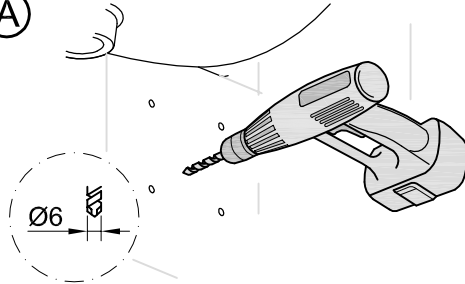

B

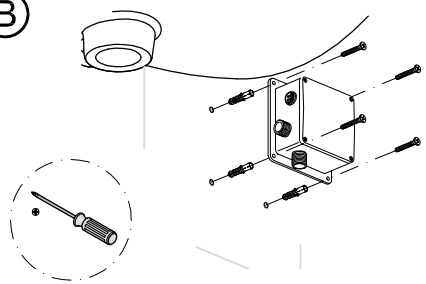

C

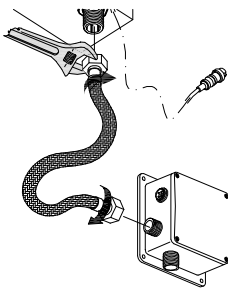

D

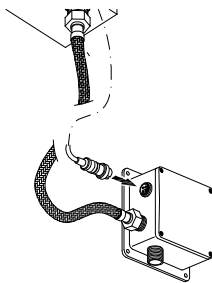

1 Água - 1 Agua - 1 Water - 1 Eau

E1

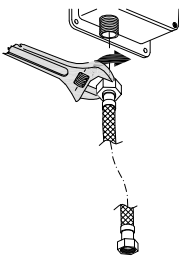

F1

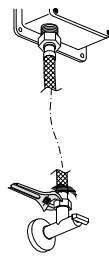

2 Águas - 2 Aguas - 2 Waters - 2 Eaux

E2

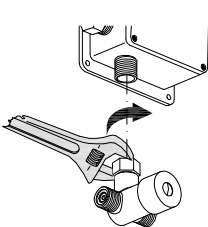

F2

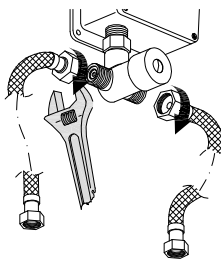

G2

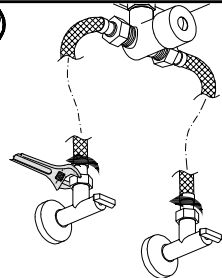

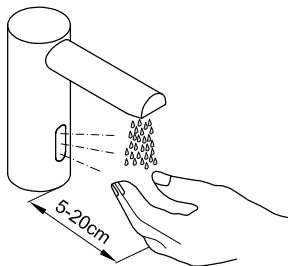
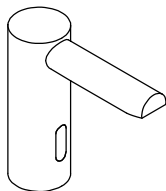
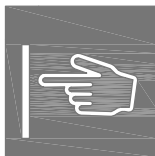
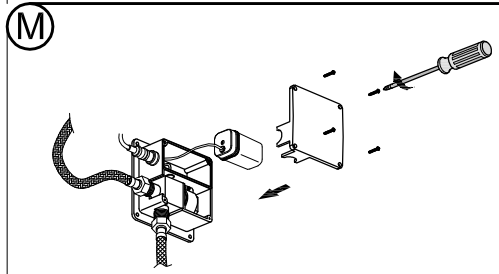
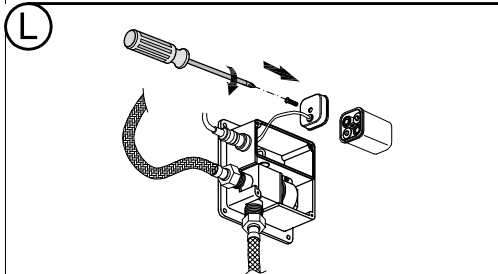
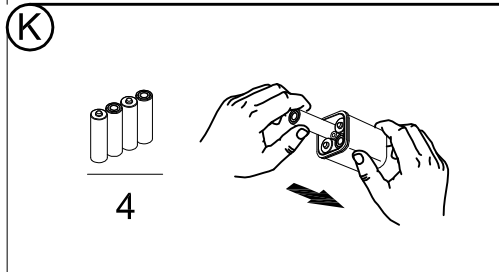
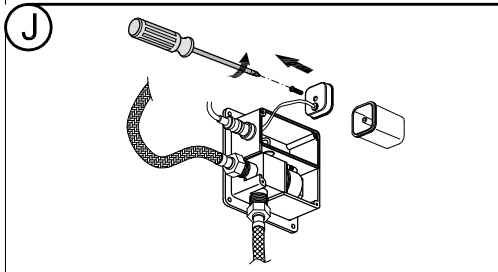
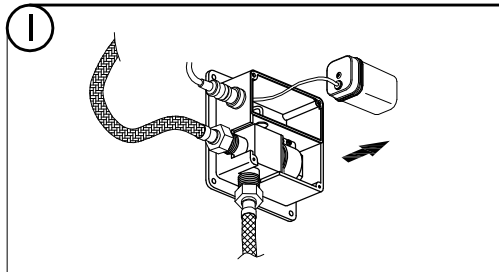
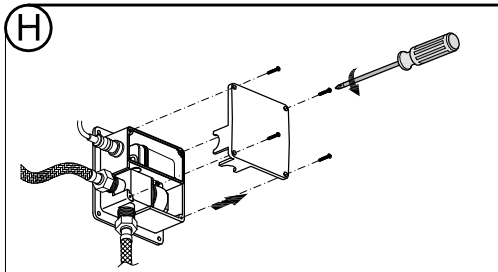
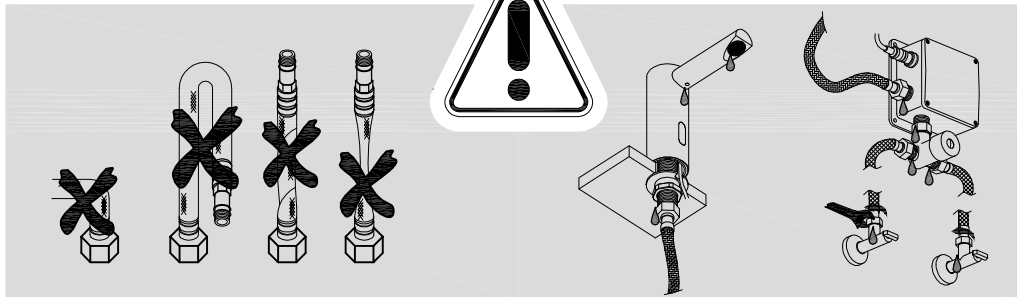

4

Pré-Instalação - Preinstalación - Pre-Instalation - Pré-Installation

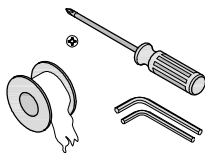
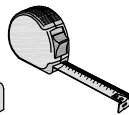
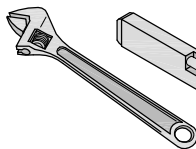
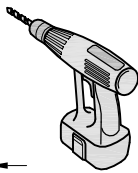
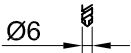
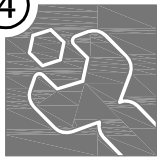

**P**  
P  
bar

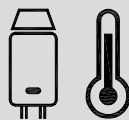
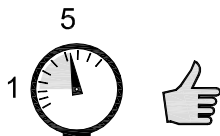
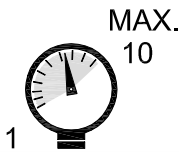

**T**  
°C

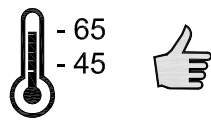
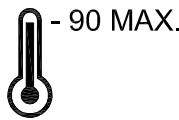

A

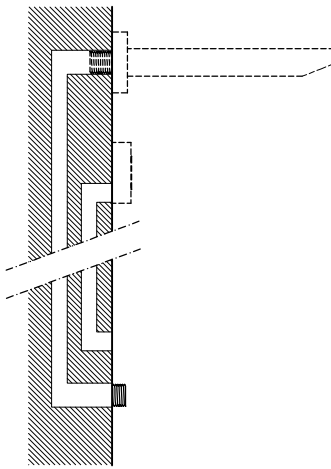
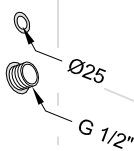
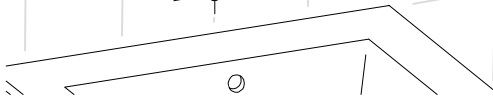
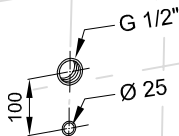

1 Água - 1 Agua - 1 Water - 1 Eau

2 Águas - 2 Aguas - 2 Waters - 2 Eaux

B1

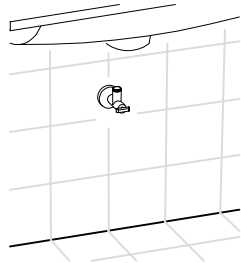
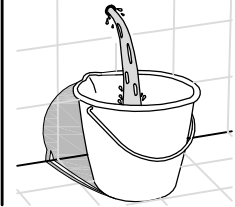

B2

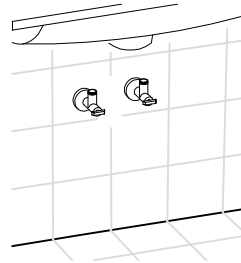
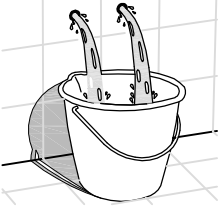



5



Instalação - Instalación - Instalation - Installation

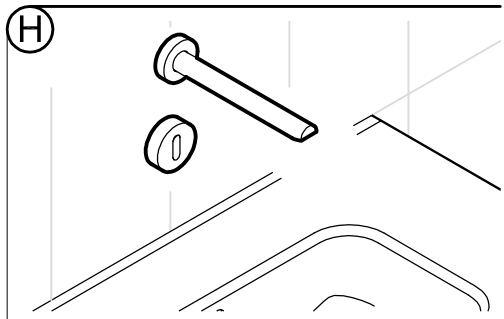
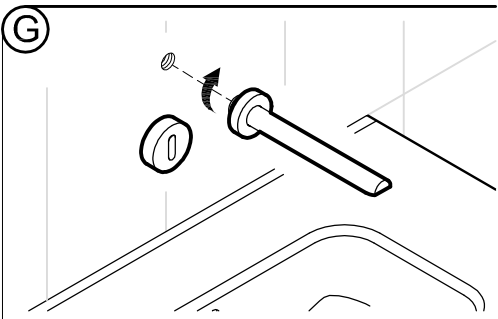
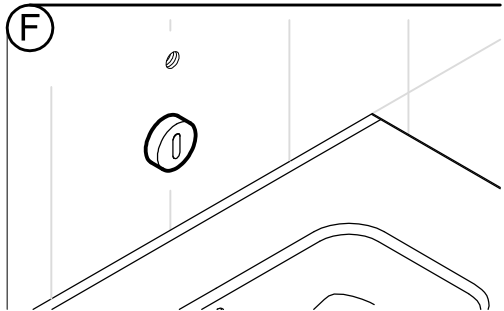
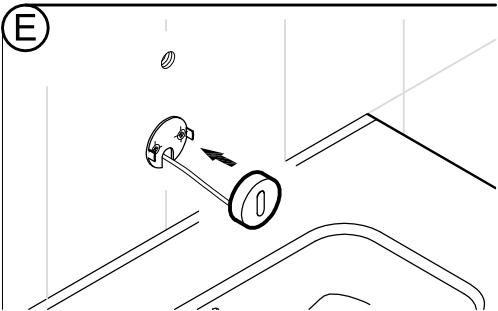
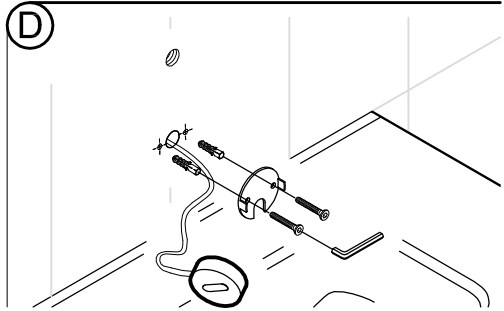
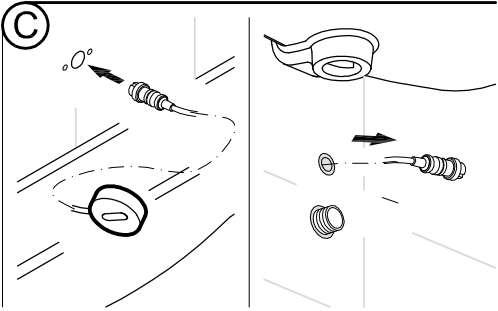
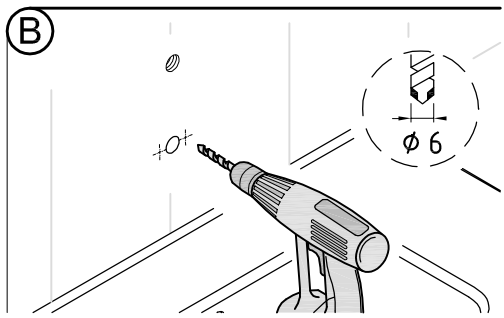
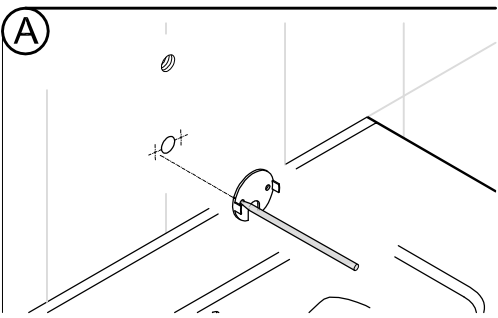

Instalação - Instalación - Instalation - Installation

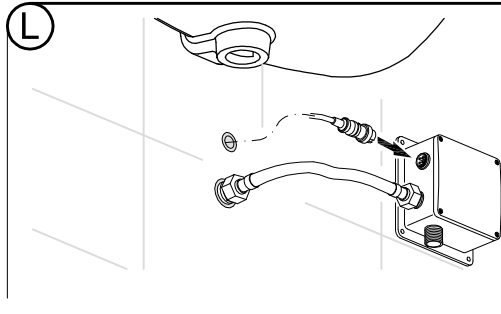
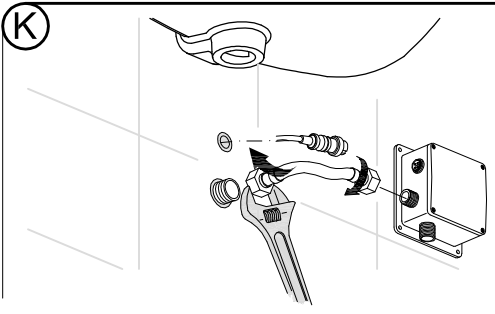
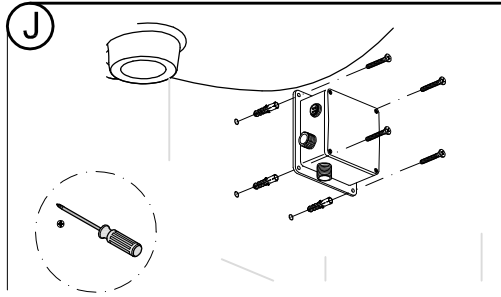
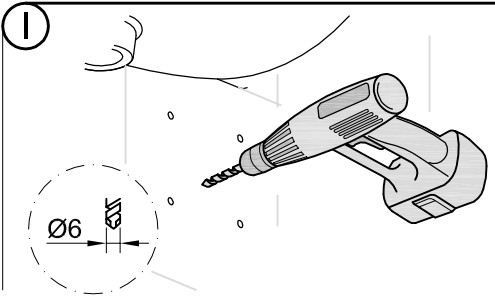

1 Água - 1 Agua - 1 Water - 1 Eau

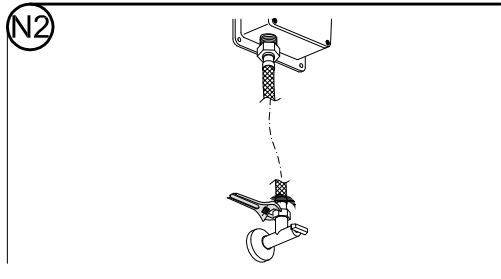
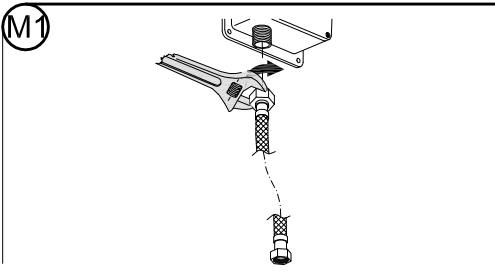

2 Águas - 2 Aguas - 2 Waters - 2 Eaux

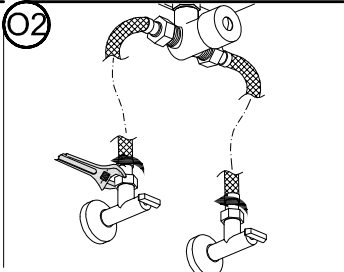
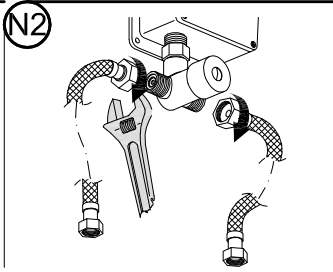
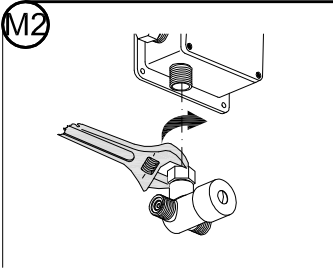

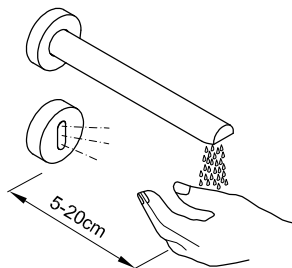
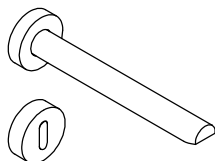
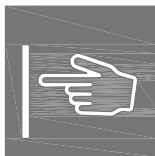
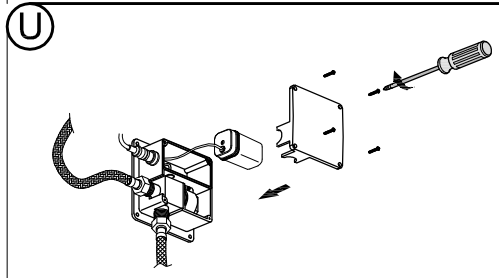
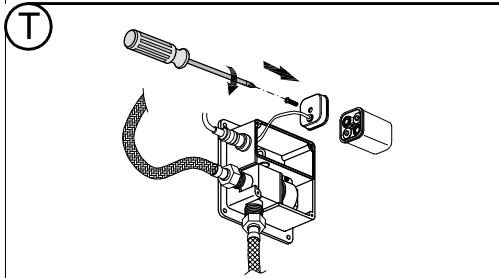
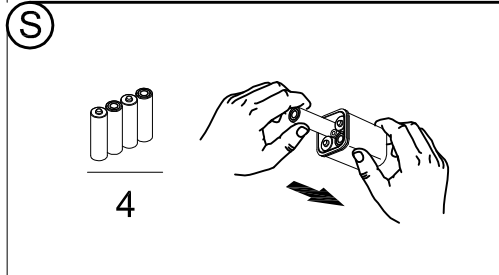
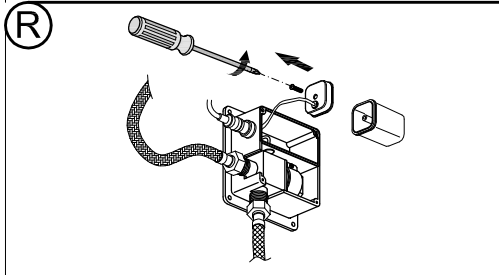
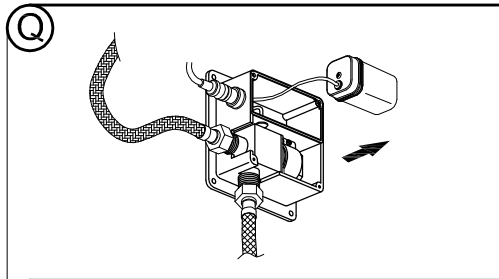
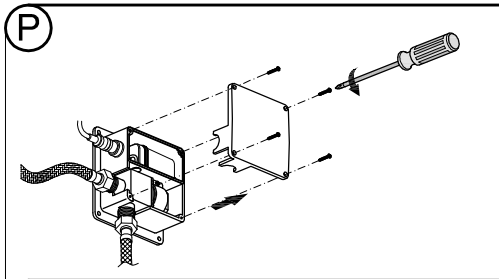

6



## PT - IMPORTANTE

- ESTAS TORNEIRAS NÃO PODEM SER MONTADAS EM PINOS DE AÇO INOX POLIDO.
- A POSIÇÃO INDICADA NO DESENHO PODERÁ VARIAR EM FUNÇÃO DAS CONDIÇÕES DO LOCAL.
- A CAIXA DO TRANSFORMADOR PODERÁ SER APLICADA POR BAIXO DO LAVATÓRIO DESDE QUE PROTEGIDA DA ÁGUA.
- RECOMENDA-SE SEMPRE A UTILIZAÇÃO DE PILHAS ALCALINAS PARA GARANTIR O BOM FUNCIONAMENTO DA CAIXA.

## ES - IMPORTANTE

- ESTAS GRIFOS NO PUEDEN ESTAR EN PINOS DE ACERO / INOX PULIDOS.
- LA POSICIÓN INDICADA EN EL ESQUEMA PODRÁ VARIAR EN FUNCIÓN DE LAS CONDICIONES CADA LOCAL DE INSTALACIÓN.
- LA CAJA DEL TRANSFORMADOR PODRÁ SER APLICADA POR DEBAJO DEL LAVABO SIEMPRE QUE PROTEGIDA DE ÁGUA.
- SE RECOMIENDA LA UTILIZACIÓN DE BATERIAS ALCALINAS DE FORMA A GARANTIR LO MEJOR FUNCIONAMIENTO POSIBLE DE LA CAJA ELECTRÓNICA.

## EN - IMPORTANT

- THESE FAUCETS CANNOT BE MOUNTED IN POLISHED STEEL / INOX PINS.
- THE POSITION INDICATED IN THE SCHEME MAY VARY ACCORDING THE CONDITIONS OF EACH INSTALLATION PLACE.
- THE ELECTRIC BOX CAN BE PLACED UNDER THE WASHBASIN IF PROTECTED FROM THE WATER.
- ALWAYS RECOMMENDS USE OF ALKALINE BATTERIES IN ORDER TO ASSURE THE BEST PERFORMANCE OF THE ELECTRONIC BOX.

## FR - IMPORTANT

- CES ROBINETS PEUVENT PAS ÊTRE MONTÉES EN PINS EN ACIER INOXYDABLE POLI.
- POSTION INDIQUÉE SUR LE DESSIN, PEUT VARIER EN FONCTION LES CONDITIONS LOCALES.
- BOITE DE TRANSFORMATEUR PEUT ÊTRE APPLIQUÉES EN VERTU DE LA BASSIN PARCE QUE C'EST EAU PROTÉGÉ.
- RECOMMANDE UTILISER ALCALINE POUR ASSURER LE BON FONCTIONNEMENT DE LE TRANSFORMATEUR.



## PT - ELIMINAÇÃO DE RESÍDUOS ELÉTRICOS E ELECTRÓNICOS

No fim da sua vida útil, o produto deve ser eliminado de acordo com os regulamentos de reciclagem actuais e não pode ser tratado como um simples resíduo urbano.

O produto deve ser eliminado em centros de reciclagem específicos ou devolvido ao revendedor no caso de ser substituído por um novo produto equivalente.

Símbolo: Indica que o produto cumpre os novos requisitos da directiva sobre protecção ambiental (2002/95/CE, 2002/96/CE, 2003/108/CE) e deve ser devidamente eliminado no fim da sua vida útil. Contacte as autoridades legais para informações sobre locais de eliminação de resíduos. O não cumprimento dos requisitos relativos à eliminação do produto indicados neste parágrafo é punido por lei.



## ES - ELIMINACIÓN DE RESIDUOS ELÉCTRICOS Y ELECTRÓNICOS

Al final de su vida útil, el producto debe eliminarse de acuerdo con las regulaciones actuales de reciclaje y no puede ser tratado como residuo urbano simple.

El producto debe ser depositado en centros de reciclaje específicos o devuelve al vendedor en el caso de ser sustituido por un producto nuevo equivalente.

Símbolo: Indica que el producto cumple con los requisitos de la nueva directiva sobre protección ambiental (2002/95 / CE, 2002/96 / CE, 2003/108 / CE). Y debe eliminarse adecuadamente al final de su vida útil. Contactar con las autoridades legales para obtener información sobre los lugares de eliminación de residuos. El incumplimiento de los requisitos para la eliminación de los productos especificados en el presente párrafo, será sancionado por la ley.



## EN - ELIMINATION OF ELECTRIC AND ELECTRONIC WASTE

At the end of its life cycle, the product must be eliminated accordingly to the present recycling regulation and it must not be managed as usual urban waste.

The product ought to be eliminated in a specialized recycling plant or returned to the retailer in case it is replaced by an equivalent product.

Symbol: it shows that the product complies with the new policy requirements on environmental protection (2002/95/CE, 2002/96/CE, 2003/108/CE ) and it must be correctly eliminated at the end of its life cycle. Contact the legal authorities to obtain information on the local of waste management. The disrespect for the requirements concerning the product elimination indicated in this paragraph is punished by law.



## FR - GESTION DE DÉCHETS ÉLECTRIQUES ET ÉLECTRONIQUES

En fin de vie, le produit doit être éliminé conformément les règlements actuels sur le recyclage et il ne peut pas être traité comme un simple déchet urbain.

Le produit doit être remis à un point de collecte approprié pour le recyclage ou renvoyé au revendeur au cas de substitution par un nouveau ou équivalent.

Symbole : indique que le produit remplit les nouvelles requises de la directive sur la protection environnementale (2002/95/CE, 2002/96/CE, 2003/108/CE) et doit être éliminé en fin de vie. Contactez les autorités pour toute sorte d'informations sur les locaux d'élimination des déchets. Le manquement au règlement relatif à l'élimination du produit indiqué est puni par une sanction prévue dans la loi.



7

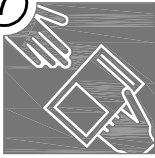

## PT - GARANTIA

Este produto tem a garantia da Empresa em relação a eventuais defeitos derivados do processo de fabrico durante 24 meses a partir da sua entrega, com extensão voluntária por parte da empresa por um período adicional de 36 meses. A data de aquisição terá de ser comprovada através de um documento de entrega ou de uma factura.

Para que esta garantia seja plenamente válida, é necessário que:

- As operações de instalação e ligação do produto à rede hidráulica tenham sido efectuadas de acordo com as indicações do Manual de Instruções de Utilização ou Instalação.
- A utilização e manutenção tenham seguido às indicações do Manual de instruções de Utilização.
- As peças de substituição utilizadas sejam exclusivamente originais.
- Assim, serão motivo de exclusão a negligência ou falta de cuidado na utilização e os erros de instalação ou qualquer outro que não se deva a defeitos de fabrico.

Durante o período de garantia, a Empresa substituirá os componentes nos quais tiver encontrado problemas de fabrico, sem encargos para o consumidor.

No caso de acabamentos de superfície especiais, tais como dourado, branco, cromado, cobre, latão envelhecido e cromado mate, existirá uma garantia de 1 ano para o acabamento e de 5 anos para os mecanismos.

A eventual reparação ou substituição de componentes do produto não prolonga a duração da presente garantia.

As peças extraíveis, cromados, peças de plástico e de esmalte, os tubos externos e os eventuais acessórios e materiais de consumo não estão cobertos por esta garantia, excepto quando se demonstrar que têm defeitos de fabrico.

Limitação da responsabilidade: A Empresa declina qualquer responsabilidade por eventuais danos que possam sofrer pessoas, objetos ou animais como consequência da inobservância das indicações do Manual de Instruções de Utilização, especialmente quanto à instalação, uso e manutenção.

Duração da garantia: Após o período de 24 meses de duração a presente garantia convencional e a sua extensão voluntária por 36 meses, cada intervenção de reparação e/ou substituição de componentes ficará a cargo do consumidor, aplicando se as tarifas vigentes no momento.

## EN - WARRANTY

The Company guarantees this product against possible manufacturing defects for 24 months from its delivery, and furthermore grants a voluntary 36 month extension. The purchase date must be verifiable through the presentation of delivery note or invoice.

For this warranty to be fully valid:

- The installation and connection operations of the product to the water system must be carried out in accordance with directions in the User or installation Instructions Manual.
- Use and maintenance must have been carried out according to the directions in the User Instructions Manual.
- The spare parts must only be original ones.
- Consequently, negligence or lack of proper care during usage, installation errors or any other reason that cannot be attributed to a manufacturing related defect will be grounds for exclusion.

During the warranty period, the Company will replace components recognized as having manufacturing defects, at no cost to the consumer.

If they have special surface finishes, such as golden, white, steel, copper, aged brass and matt chrome, they will have a warranty of 1 year for the surface finish and 5 years for the mechanisms.

Possible repairs or replacements of components are not grounds for extension of the duration of this warranty.

This warranty does not cover removable parts, controls, plastic and enameled parts, the outer tubes and possible consumable accessories and materials, unless they have proven manufacturing defects.

Liability limitation: The Company assumes no liability for any possible harm or damage that may occur to individuals, objects and animals, owing to failure to comply with the directions in the User instructions Manual, particularly as regards installation, use and maintenance.

Warranty expiry: After the 24 month period of this conventional warranty and the voluntary extension for a further 36 months, each component repair and/or replacement, intervention will be paid for by the Consumer according to the current rates at that time.

## E - GARANTÍA

Este producto está garantizado por la Empresa ante eventuales defectos derivados del proceso de fabricación durante 24 meses a partir de su entrega, con extensión voluntaria por parte de la firma por un periodo adicional de 36 meses. La fecha de adquisición deberá poder ser constatada mediante documento de entrega o factura.

Para que esta garantía tenga plena validez, es preciso que:

- Las operaciones de instalación y conexionado del producto a la red hidráulica hayan sido efectuadas según las indicaciones del libro de instrucciones de Uso e Instalación.
- La utilización y mantenimiento hayan seguido las Indicaciones del libro de Instrucciones de Uso.
- Los recambios utilizados sean exclusivamente originales.
- Por consiguiente serán motivo de exclusión la negligencia o falta de cuidado en el uso y los errores de instalación o cualquier otro que no pueda achacarse a defecto de fabricación.

Durante el periodo de garantía, la Empresa reemplazará los componentes que hayan reconocido con vicios de fabricación, sin cargos para el consumidor.

Si son acabados de superficie especiales, tales como dorado, blanco, acerado, cobre, latón envejecido y cromo mate, tendrán una garantía de 2 años en cuanto al acabado de superficie y de 5 años en los mecanismos.

La eventual reparación o sustitución de componentes del producto no extiende la duración de la presente garantía.

Las piezas extraíbles, mandos, partes de plástico y esmalte, los tubos externos y los eventuales accesorios y materiales de consumo no quedan cubiertas por esta garantía, excepto cuando se demuestre que tengan defectos producidos de fabricación.

Limitación de la responsabilidad: La Empresa declina toda responsabilidad por eventuales daños que puedan derivar a personas, cosas o animales, como consecuencia de la inobservancia de las indicaciones del libro de instrucciones de Uso y especialmente a temas de instalación, uso y mantenimiento.

Caducidad de la garantía: Transcurrido el periodo de 24 meses de duración de la presente Garantía convencional, y la extensión voluntaria por 36 meses más, cada intervención de reparación y/o sustitución de componentes irán a cargo del consumidor, según las tarifas vigentes en el momento.

## FR - GARANTIE

Entreprise garantit cet article contre d'éventuels défauts de fabrication durant 24 mois à compter de sa livraison, avec une extension volontaire du fabricant par une période supplémentaire de 36 mois. La date d'acquisition devra être justifiée sur présentation du bon de livraison ou de la facture.

Pour que cette garantie soit valable, il faut que:

- Les opérations d'installation et de branchement du produit au réseau hydraulique aient été réalisées conformément au manuel d'utilisation ou d'installation.
- L'utilisation et l'entretien aient respecté les instructions du manuel d'utilisation.
- Les pièces de rechange soient uniquement des pièces originales.
- Par conséquent, sont exclus de la garantie, la négligence ou le manque de soin lors de l'utilisation, et les erreurs d'installation ou tout autre événement non imputable à un défaut de fabrication.

Pendant la période de garantie, l'entreprise remplacera gratuitement les éléments dont il aura admis les vices de fabrication.

Si s'agit de finitions de surface spéciales, telles que doré, blanc, acier, cuivre, laiton vieilli et chrome mat, la garantie sera de 1 an pour la finition de surface et de 5 ans pour les mécanismes.

La réparation ou le remplacement éventuel des éléments du produit ne prolonge pas la durée de la présente garantie.

Les pièces démontables, les commandes, les pièces en plastique et émaillées, les tubes externes, les accessoires éventuels et le matériel forgible ne sont pas couverts par cette garantie, sauf s'il est démontré qu'ils présentent des défauts de fabrication.

Limitation de responsabilité: L'entreprise décline toute responsabilité pour les dommages éventuels aux personnes, choses ou animaux, provoqués par le non respect des instructions du manuel d'utilisation, notamment en ce qui concerne l'installation, l'utilisation et l'entretien.

Durée de la garantie: Après la période de 24 mois de la garantie habituelle et l'extension volontaire de 36 mois supplémentaires, toute intervention de réparation et/ou remplacement de pièces sera à la charge du client, selon les tarifs en vigueur à cette date.



SANITANA - Fábrica de Sanitários de Anadia S.A. - Zona Industrial de Anadia - Apartado 45  
3781-909 Anadia (Portugal) - T.:+351 231 519 500 - F.:+351 231 511 024 - e-mail: [Info@sanitana.com](mailto:Info@sanitana.com) - [assistencia.apolo@sanitana.pt](mailto:assistencia.apolo@sanitana.pt)  
[www.sanitana.com](http://www.sanitana.com) - [www.sanitanaprofissional.com](http://www.sanitanaprofissional.com)

-----

All information and dimensions should be considered merely approximate and are subject to modification without notice. This document cancels the former ones.  
Toutes les dimensions et Informations sont à titre Indicatif et susceptibles de modifications sans préavis. Ce document annule les précédents.

Las medidas e información son a título orientativo y susceptibles de modificación sin previo aviso. Este documento anula los anteriores.

As Informações e medidas são a título orientativo e susceptíveis de modificações sem aviso prévio. Este documento anula os anteriores.

-----



This Company respects nature, and therefore all our manuals are printed with papers that help to maintain the environment, using only ECF pulp derived from renewable forests.

Cette société respecte la nature et c'est donc pour cela que tous nos manuels sont imprimés avec du papier qui aide l'environnement, en utilisant seulement les pâtes ECF provenant de bois renouvelables.

Esta empresa respeta la naturaleza, y por ello todos nuestros manuales están impresos con papeles que ayudan a mantener el medio ambiente, utilizando únicamente pastas ECF procedentes de bosques renovables.

Esta Empresa respeita a natureza, por isso, todos os nossos manuais são impressos com papéis que ajudam a manter o meio ambiente, utilizando pastas ECF provenientes de florestas renováveis.